

DMT070WSHMCM1-3A

PRODUCT SPECIFICATION

Version 1.0
Jul 31, 2023



<i>Customer's Approval</i>	
<u>Signature</u>	<u>Date</u>

Prepared by *Yvette Hsieh*
Approved by *Eric Wan*

Revision History

VERSION	DATE	DESCRIPTION	AUTHOR
0.1	Jun 13, 2023	Preliminary	Yvette Hsieh
1.0	Jul 31, 2023	Add the product's picture, P7 weight. Modified P8 drawing, P5. Operating and storage temperature, P17 Sleep mode, CH 5. Optical Specification and CH9. Reliability Tests.	Yvette Hsieh

Legal Notice

Copyright ©2023 Densitron

All information contained in this document is proprietary and confidential to Densitron and is subject to a non-disclosure agreement. Unauthorized use, duplication, modification or disclosure of this information by any means without prior consent of Densitron is prohibited.

Every effort has been made to ensure the accuracy of this document; however, Densitron accepts no responsibility for any inaccuracies, errors or omissions herein. Densitron reserves the right to change specifications without prior notice in its absolute discretion, to supply the best product possible. Where Densitron or any of its group companies has (i) made a change to a product to incorporate a specific customer requirement or (ii) has created a design to a customer's specific requirements, in either case the customer will indemnify and hold the relevant Densitron entity harmless against any claim that delivery against such requirement breaches any intellectual property or other rights of any 3rd party.

All brands and trademarks are the property of their respective owners and are hereby fully acknowledged.

Table of Contents

1. GENERAL DESCRIPTION	5
1.1 Introduction	5
1.2 Main Features	5
1.3 CTP Features	6
2. MECHANICAL SPECIFICATION	7
2.1 Mechanical Characteristics	7
2.2 Mechanical Drawing.....	8
3. ELECTRICAL SPECIFICATION	9
3.1 Absolute Maximum Ratings.....	9
3.2 DC Characteristics	9
3.3 Interface Pin Assignment	10
3.4 Block Diagram	12
3.5 Timing Characteristics	13
4. ELECTRICAL SPECIFICATION TOUCH	16
4.1 Electrical Characteristics	16
4.2 CTP Interface timing Characteristics	16
5. OPTICAL SPECIFICATION	17
5.1 Optical Characteristics	17
6. LED BACKLIGHT SPECIFICATION	20
6.1 LED Backlight Characteristics	20
6.2 Internal Circuit Diagram	20
7. PACKAGING	21
8. QUALITY ASSURANCE SPECIFICATION.....	22
8.1 Conformity	22
8.2 Delivery Assurance.....	22
8.3 Dealing with Customer Complaints.....	23
9. RELIABILITY SPECIFICATION	24
9.1 Reliability Tests.....	24
10. HANDLING PRECAUTIONS.....	26

10.1	Handling Precautions	26
10.2	Storage Precautions	27
10.3	Designing Precautions.....	27
10.4	Operation Precautions	28
10.5	Other Precautions	28

CONFIDENTIAL

1. General Description

1.1 Introduction

This is a 7.0" size colour active matrix TFT LCD module that uses amorphous silicon TFT as a switching device and all-round view. The display is normally black mode, transmissive, and featuring high contrast and excellent colour saturation. The resolution of the TFT-LCD is 1024 x 600 and can display up to 16.7M colours.

1.2 Main Features

Item	Contents
Display Type	TFT LCD
Screen Size	7.0" Diagonal
Display Format	1024 x RGB x 600 Dots
No. of Colour	16.7 M
Overall Dimensions	165.0 (W) x 100.0 (H) x 5.7 (D) mm
Active Area	154.21 (W) x 85.92 (H) mm
Mode	Normally Black / Transmissive / IPS
Surface Treatment	Glare (6H)
Viewing Direction	All round
Interface	MIPI
Driver IC	EK79007AD3+EK73217BCGA
Backlight Type	LED, White, 36 chips
Operating Temperature	-20°C ~ +70°C
Storage Temperature	-30°C ~ +80°C
ROHS	Compliant to RoHS 2.0

1.3 CTP Features

Item	Contents
Touch Panel	PCT
Touch Interface	I ² C
Touch Driver IC	FT5446DQS
Touch Resolution	1024 x 600
Bonding Type	Tape Bonding
Touch Mode	5 Finger

2. Mechanical Specification

2.1 Mechanical Characteristics

Item	Characteristic	Unit
Display Format	1024 x RGB x 600	Dots
Overall Dimensions	165.0(W) x 100.0(H) x 5.7(D)	mm
Active Area	154.21 (W) x 85.92 (H)	mm
Pixel Pitch	0.0502 (W) x 0.17432 (H)	mm
Weight	211.85	g
IC Controller/Driver	EK79007AD3+EK73217BCGA	

2.2 Mechanical Drawing

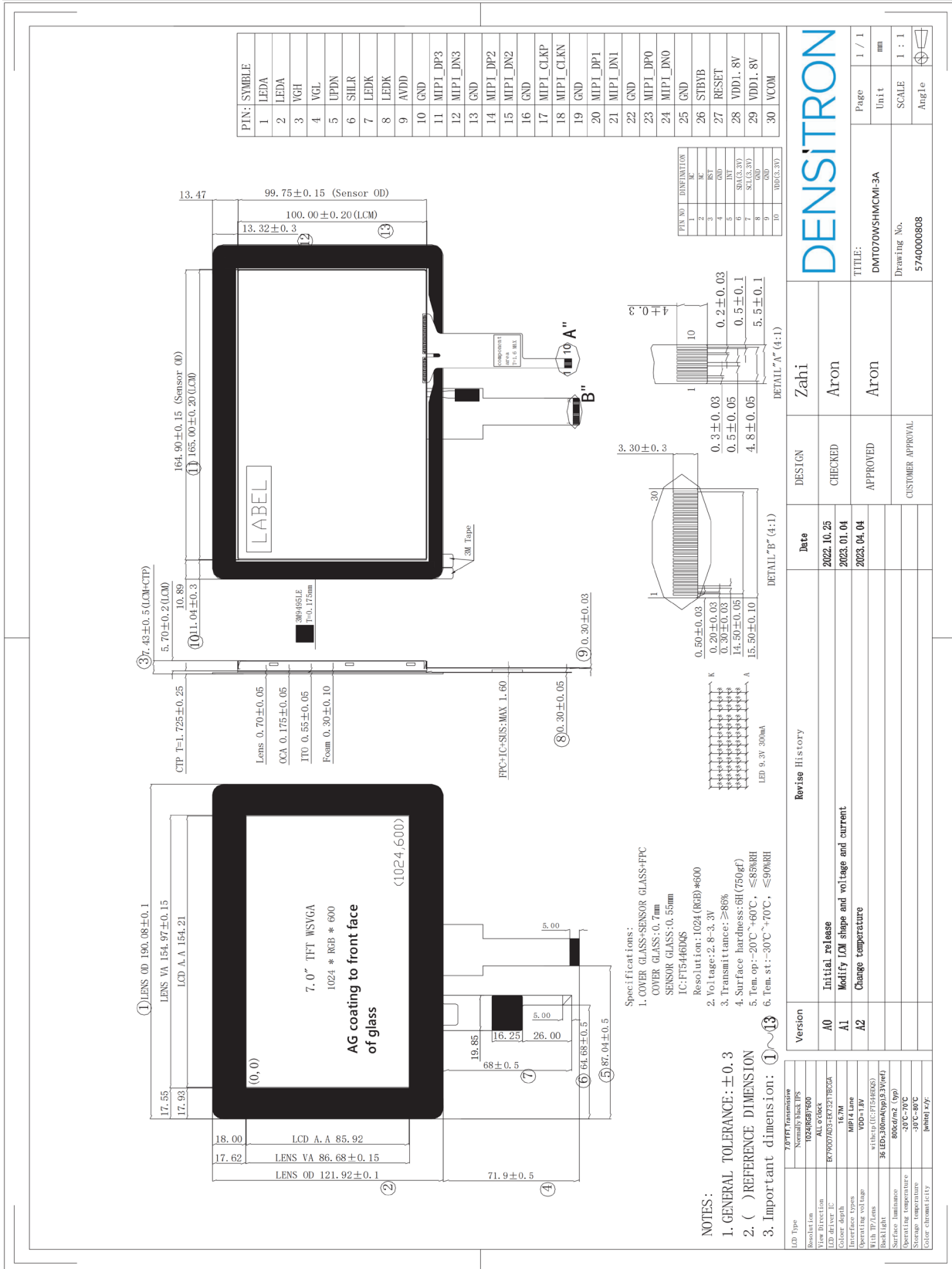

DENSITRON

TITLE: DMT070WSHMCMI-3A
Drawing No. 574000808

Page	1 / 1
Unit	mm
SCALE	1 : 1
Angle	

Version	Date	Design
A0	2022.10.25	Zahi
A1	2023.01.04	Aron
A2	2023.04.04	Aron

Revise History
Initial release
Modify LCM shape and voltage and current
Change temperature

LED Type	Resolution	View Direction	LED driver IC	Colour depth	Interface types	Operating voltage	Backlight	Surface luminance	Operating temperature	Storage temperature	Color chromaticity
MIPI	1024(RGB)*600	ALL 0°/90°	BP790703-TE7217BGA	16.7M	MIPI 4 Lane	VDD1.8V	36 LEDs (3000K±3V)red	800cd/m² (typ)	-20°C~+70°C	-30°C~+60°C	white 3+3

3. Electrical Specification

3.1 Absolute Maximum Ratings

Item	Symbol	Min	Max	Unit	Note
Supply Voltage (Analog)	VCC~GND	-	-	V	-
Logic signal voltage(I/O)	IOVCC~GND	-	-	V	-
Operating Temperature	T _{OP}	-20	+70	°C	-
Storage Temperature	T _{ST}	-30	+80	°C	-

Note 1: When this module is used beyond the above absolute maximum ratings, permanent breakage of the module may occur. For normal operations, it is desirable to use this module under the conditions according to Section 3.2 “Electrical Characteristics”, to avoid malfunctioning.

Note 2: Background colour changes slightly depending on ambient temperature. This phenomenon is reversible.

Note 3: Please refer to item of RELIABILITY.

3.2 DC Characteristics

T_a=25±2°C

Item	Symbol	Condition	Min	Typ.	Max	Unit	Note
Supply Voltage 1	VDD	-	1.8	1.85	1.9	V	-
Supply Voltage 2	AVDD	-	9.1	9.6	10.1	V	-
Supply Voltage 3	VGH	-	16	18	20	V	-
Supply Voltage 4	VGL	-	-6.5	-6.0	-5.5	V	-
Supply Voltage 5	VCOM	-	3.2	3.3	3.4	V	-
Current Consumption	I _{DD}	-	-	360	-	mA	Normal mode
	I _{DD-SLEEP}	-	-	2	-	mA	Sleep mode
Input voltage “L” Level	V _{IL}	-	GND	-	0.3V _{DD1}	V	D _{VDD} =3.0~3.6
Input voltage “H” Level	V _{IH}	-	0.7V _{DD1}	-	V _{DD1}	V	
Output voltage “L” Level	V _{OL}	-	0	-	0.2V _{DD}	V	I _{OL} =1mA
Output voltage “H” Level	V _{OH}	-	0.8V _{DD1}	-	V _{DD1}	V	I _{OH} =1mA

3.3 Interface Pin Assignment

3.3.1 TFT Pin Assignment

No.	Symbol	I/O	Function
1	LEDA	P	LED Anode
2	LEDA		
3	VGH	P	Gate ON Voltage
4	VGL	P	Gate OFF Voltage
5	UPDN	I	Up/down selection
6	SHLR	I	Left/right selection
7	LEDK	P	LED Cathode
8			
9	AVDD	P	Power for Analog Circuit
10	GND	P	System Ground. (0V)
11	MIPI_DP3	I	MIPI Positive data input
12	MIPI_DN3	I	MIPI Negative data input
13	GND	P	System Ground. (0V)
14	MIPI_DP2	I	MIPI Positive data input
15	MIPI_DN2	I	MIPI Negative data input
16	GND	P	System Ground. (0V)
17	MIPI_CLKP	I	MIPI Positive clock input
18	MIPI_CLKN	I	MIPI Negative clock input
19	GND	P	System Ground. (0V)
20	MIPI_DP1	I	MIPI Positive data input
21	MIPI_DN1	I	MIPI Negative data input
22	GND	P	System Ground. (0V)
23	MIPI_DP0	I	MIPI Positive data input
24	MIPI_DN0	I	MIPI Negative data input
25	GND	P	System Ground. (0V)
26	STBYB	I	Standby mode, Normally pulled high STBYB = "1", normal operation STBYB = "0", timing controller, source driver will turn off, all output are High-Z

No.	Symbol	I/O	Function
27	RESET	I	Reset input signal, active low
28	VDD1.8V	P	Power voltage for digital circuit 1.8V
29			Power Supply
30	VCOM	P	Common Voltage.

3.3.2 CTP Pin Assignment

No.	Symbol	I/O	Function
1	NC	-	Not connected
2	NC	-	Not connected
3	RST	I	CTP-RESET
4	GND	P	CTP-GROUND
5	INT	O	CTP-INTERRUPT
6	SDA (3.3V)	I/O	CTP-DATA
7	SCL (3.3V)	I	CTP-CLOCK
8	GND	P	CTP-GROUND
9	GND	P	CTP-GROUND
10	VDD (3.3V)	P	CTP-POWER

3.4 Block Diagram

TBD

CONFIDENTIAL

3.5 Timing Characteristics

3.5.1 Reset Timing

Item	Symbol	Min	Typ.	Max	Unit
Reset pulse width	t_{RW}	10	-	-	us
Reset complete time	t_{RT}	-	-	5	us
Negative spike noise width	t_{NNS}	-	-	100	ns

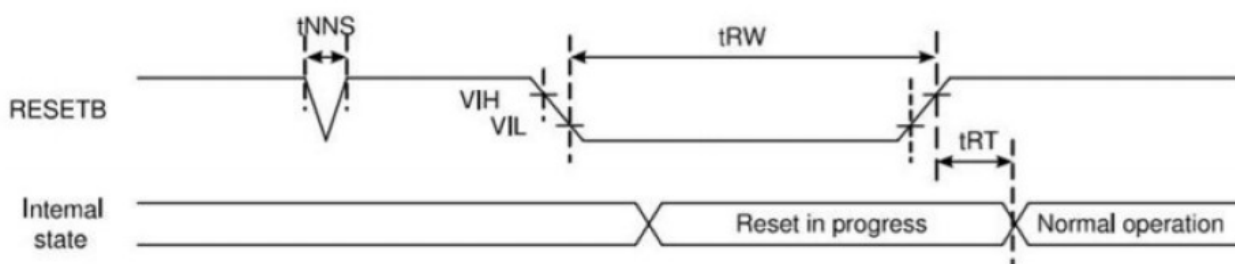

CONFIDENTIAL

3.5.2 Non-Burst Mode with Sync Pulses

With the format, the goal is to accurately convey DPI-type timing over the DSL Link. This included matching DPI pixel-transmission rates, and widths of timing events like sync pulses. An example of this mode is shown in Figure below.

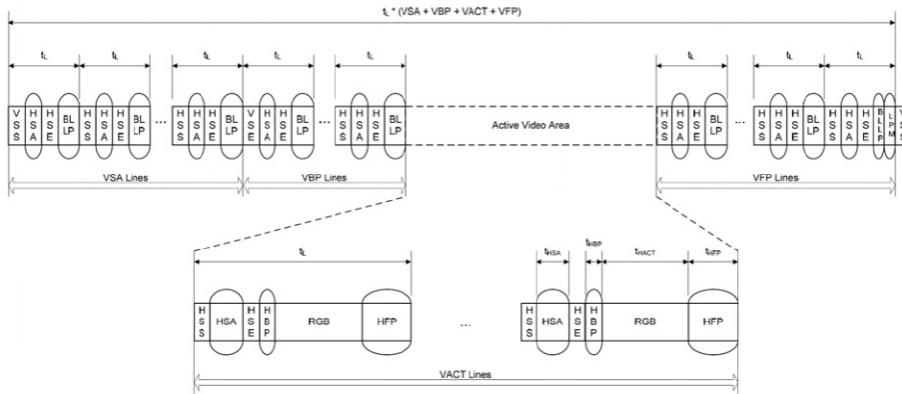

Normally, periods shown as HAS (Horizontal Sync Active), HBP (Horizontal Back Porch) and HFP (Horizontal Front Porch) are filled by Blanking Packets, with lengths (including packet overhead) calculated to match the period specified by the peripheral's data sheet. Alternatively, if there is sufficient time to transition from HS to LP mode and back again, a timed interval in LP mode may substitute for a Blanking Packet, thus saving power.

3.5.3 Non-Burst Mode with Sync Events

This mode is a simplification of the format described in section "Non-Burst Mode with Sync Pulse". Only the start of each synchronization pulse is transmitted. The peripheral may regenerate sync pulse needed from each Sync Event packet received. Pixels are transmitted at the same rate as they would in a corresponding parallel display interface such as DPI-2. An example of this mode is shown in Figure below.

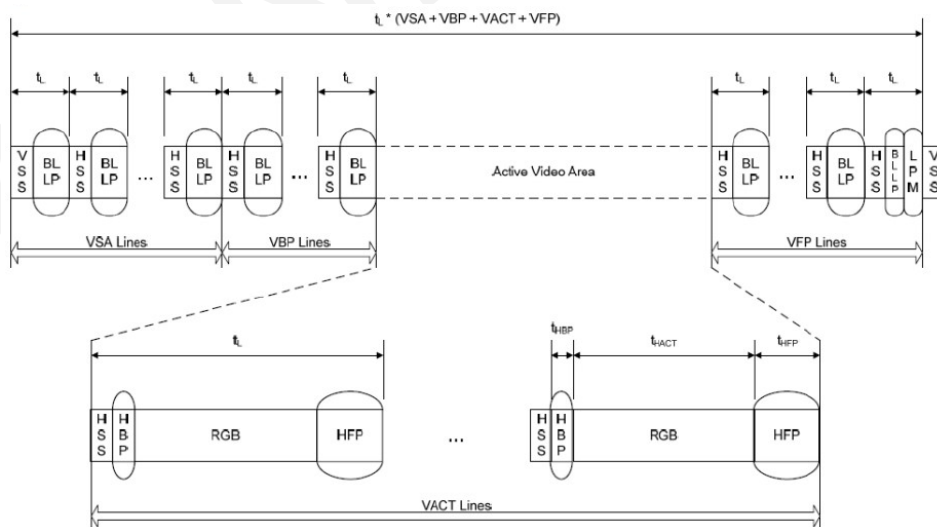

As with the previous Non-Burst Mode, if there is sufficient time to transition from HS to LP mode and back again, a timed interval in LP mode may substitute for a Blanking Packet, thus saving power.

3.5.4 Burst Mode

In this mod blocks of pixel data can be transferred in a shorter time using a time-compressed burst format. This is a good strategy to reduce overall DSI power consumption, as well as enabling larger blocks of time for other data transmissions over the Link in either direction. There may be a line buffer or similar memory on the peripheral to accommodate incoming data at high speed. Following HS pixel data transmission, the bus goes to Low Power Mode, during which it may remain idle, i.e the host processor remains in LP-11 state, or LP transmission may take place in either direction. If the peripheral takes control of the bus for sending data to the host processor, its transmission time shall be limited to ensure data underflow does not occur from its internal buffer memory to the display device. An example of this mode is shown in Figure below.

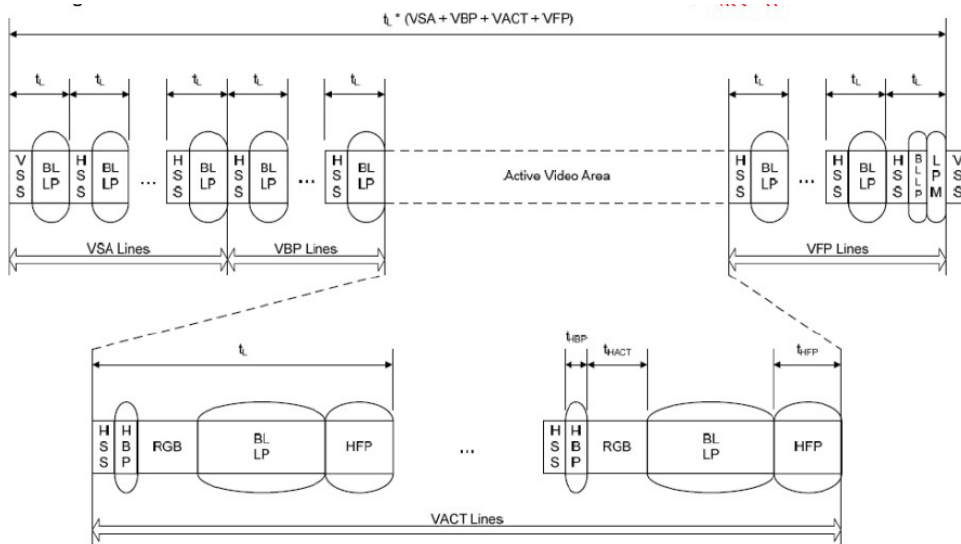

Similar to the Non-Burst Mode scenario, if there is sufficient time to transition from HS to LP mode and back again, a timed interval in LP mode may substitute for a Blanking Packet, thus saving power.

4. Electrical Specification Touch

4.1 Electrical Characteristics

Item		Specification
Operating Voltage		DC 2.8~3.3V
Power Consumption (IDD)	Active Mode	2~4.5mA
	Sleep Mode	0.03uA

4.2 CTP Interface timing Characteristics

Item	Min	Max	Unit	Note
Supply Voltage (Analog)	-	400K	Hz	-
Bus Free Time Between a STOP and START Condition	1.3	-	uS	-
Hold Time (repeated) START Condition	0.6	-	uS	-
Data Setup Time	100	-	nS	-
Setup Time for Repeated START Condition	0.6	-	uS	-
Setup Time for STOP Condition	0.6	-	uS	-

5. Optical Specification

5.1 Optical Characteristics

Characteristics		Symbol	Conditions	Min	Typ.	Max	Unit	Note
Contrast Ratio		CR	$\theta = 0^\circ$	-	800	-	-	2, 6
Response time		TR + TF	Normal	-	-	45	ms	5
NTSC		-	viewing angle	50%	60%	-	-	3
Viewing Angle	Left	θ_{x-}	$CR \geq 10$	-	85	-	Deg	2, 6, 7
	Right	θ_{x+}		-	85	-		
	Up	θ_{y+}		-	85	-		
	Down	θ_{y-}		-	85	-		
Colour Chromaticity	Red	Rx	$\theta = 0^\circ$ Normal viewing angle	-0.04	0.583	+0.04	-	3
		Ry			0.353			
	Green	Gx			0.323			
		Gy			0.571			
	Blue	Bx			0.145			
		By			0.094			
	White	Wx			0.296			
		Wy			0.322			
Luminance (IF =20mA)		Lv	-	-	800	-	cd/m ²	-
Uniformity		AVg	-	80	-	-	%	10
Cross talk		Ct	-	-	-	2%	-	9
Transmittance		Trans	-	-	-	-	-	4

Note 1: Measuring Condition = in dark room, at ambient temperature 25±2°C, for 15min, warm-up time.

Note 2: To be measured with a viewing cone of 2°by Topcon luminance meter BM-5A.

Note 3: To be measured with Otsuta chromaticity meter LCF-2100M, CF only measure under C light simulation.

Note 4: CTC shipping status is cell without polarizer. Transmittance of Specification is cell with polarizer.

The tolerance of Transmittance is ±10%.

Note	Item	Test method
5	Definition of Response time	<p>The output signals of TRD-100 are measured when the input signals are changed to "White" (falling time) and from "White" to "Black" (rising time), respectively. The interval is between the 10% and 90% of amplitudes. Refer to figure as below.</p>
6	Definition of Contrast Ratio (CR)	<p>Contrast ratio (CR) = $\frac{\text{Luminance measured when LCD is at "white state"}}{\text{Luminance measured when LCD is at "black state"}}$</p>
7	Definition of Viewing Angle	
8	Definition of Optical Measurement Setup	

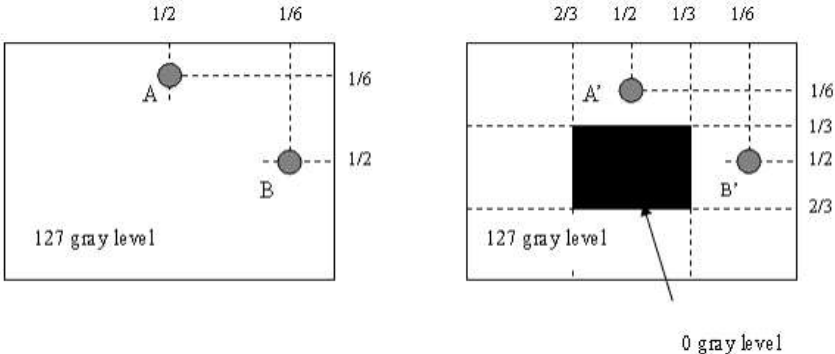
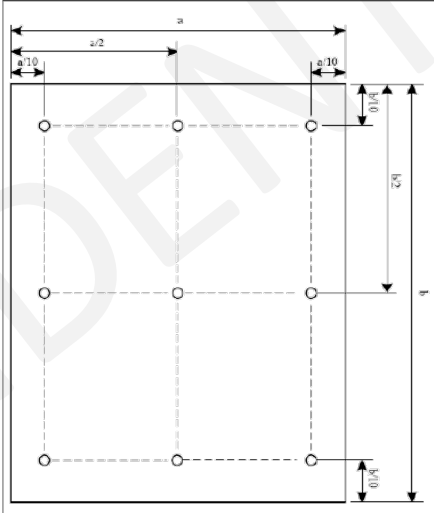
Note	Item	Test method
9	Definition of Cross Talk	 <p>127 gray level</p> <p>0 gray level</p> <p>$LA - LA' / LA \times 100\% = 2\% \text{ max.}$, LA and LA' are brightness at location A and A'.</p> <p>$LB - LB' / LB \times 100\% = 2\% \text{ max.}$, LB and LB' are brightness at location B and B'.</p>
10	Definition of Luminance Uniformity	<p>Luminance Uniformity of these 9 points is defined as below:</p>  <p>Uniformity = $\frac{\text{minimum luminance in 9 points (1-9)}}{\text{maximum luminance in 9 points (1-9)}}$</p> <p>Luminance = $\frac{\text{Total Luminance of 9 points}}{9}$</p>

6. LED Backlight Specification

6.1 LED Backlight Characteristics

Item	Symbol	Condition	Min	Typ.	Max	Unit	Note
Voltage for LED backlight	V_f	-	-	9.3	-	V	-
Current for LED backlight	I_f	-	-	300	-	mA	-
Power consumption	Wbl	-	-	2790	-	mW	-
LED Life Time	-	-	30000	-	-	Hour	-

Note 1: The LED life time is defined as the module brightness decrease to 50% original brightness at $T_a=25^{\circ}\text{C}$, 60%RH $\pm 5\%$.

Note 2: The life time of LED will be reduced if LED is driven by high current, high ambient temperature and humidity conditions.

Note 3: Typical operating life time is an estimated data.

Note 4 :Permanent damage to the device may occur if maximum values are exceeded or reverse voltage is loaded .Functional operation should be restricted to the conditions described under normal operating conditions..

6.2 Internal Circuit Diagram

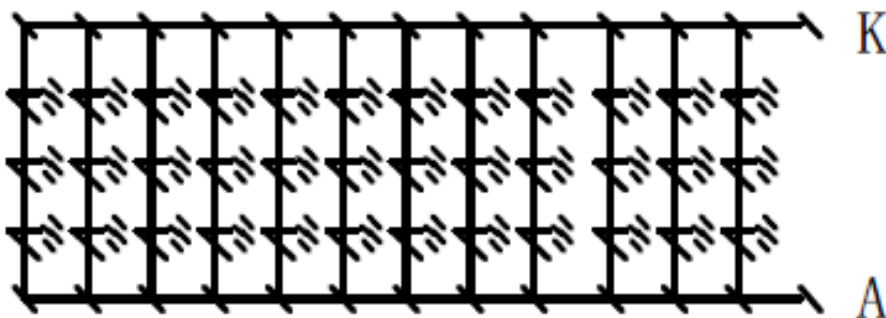

7. Packaging

TBD

CONFIDENTIAL

8. Quality Assurance Specification

8.1 Conformity

The performance, function and reliability of the shipped products conform to the Product Specification.

8.2 Delivery Assurance

8.2.1 Delivery Inspection Standards

Class II, Normal Inspection, MIL-STD-105E

8.2.2 Zone Definition

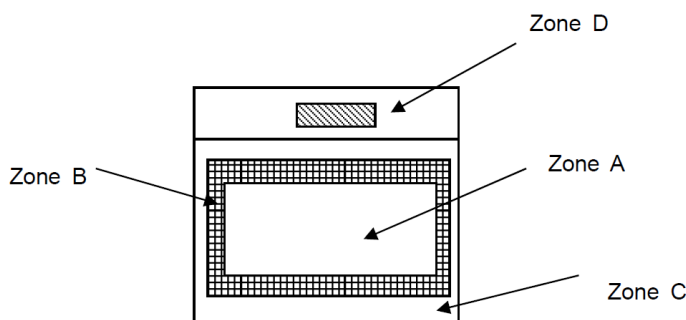

Zone A: Effective Viewing Area (Character or Digit can be seen)

Zone B: Viewing Area except Zone A

Zone C: Outside (Zone A + Zone B) Area which cannot be seen after assembly by customer.

Zone D: IC Bonding Area

Note: Generally, visual defects in Zone C can be ignored when it doesn't affect product function or appearance after assembly by customer

8.3 Dealing with Customer Complaints

8.3.1 Non-conforming Analysis

Purchaser should supply Densitron with detailed data of non-conforming sample.

After accepting it, Densitron should complete the analysis in reasonable time and update the status to the purchaser.

8.3.2 Handling of Non-conforming Displays

If any non-conforming displays are found during customer acceptance inspection which Densitron is clearly responsible for, return them to Densitron.

Both Densitron and customer should analyse the reason and discuss the handling of non-conforming displays when the reason is not clear.

Equally, both sides should discuss and come to agreement for issues pertaining to modification of Densitron quality assurance standard.

9. Reliability Specification

9.1 Reliability Tests

Test Item	Test Condition	Inspection after test
High Temperature Operation	70±2°C, 96 hrs	Inspection after 2~4hours storage at room temperature, the sample shall be free from defects: 1) Air bubble in the LCD; 2) Non-display; 3) Missing segments/line; 4) Glass crack; 5) Current IDD is twice higher than initial value.
Low Temperature Operation	-20°±2C, 96 hrs	
High Temperature Storage	80±2°C, 96 hrs	
Low Temperature Storage	-30±2°C, 96 hrs	
Temperature Cycle	-20±2°C ~ 25~ 70± 2°C × 10 cycles (30 min.) (5min.) (30min.)	
Damp Proof Test	60°C ±5°C × 90%RH, 96 hours	
Vibration Testt	Frequency 10Hz~55Hz Stroke: 1.5mm Sweep: 10Hz~55 Hz~10Hz 2 hours For each direction of X, Y, Z.	
Shock Test	Half-sine, wave, 300m/s	
Packing Drop Test	Height: 60 cm 1 corner, concrete floor	
Electrostatic Discharge Test	C=150pF, R=330 Ω Air: ±8KV 150pF/330Ω 9 times Contact: ±4KV,9 times	
Image Sticking	25°C, 60%RH	30mins

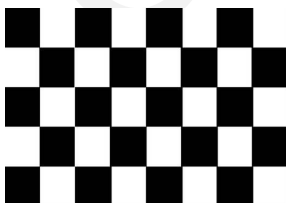

9.1.1 Inspection Check Standard

After the completion of the described reliability test, the samples are to be left at room temperature for 4 hrs prior to conducting the inspection check at 25 ± 5 °C, $65\pm 10\%$ RH.

CONFIDENTIAL

10. Handling Precautions

10.1 Handling Precautions

- 1) Since the display panel is being made of glass, do not apply mechanical impacts such as dropping from a high position.
- 2) If the display panel is broken by some accident and the internal organic substance leaks out, be careful not to inhale nor lick the organic substance.
- 3) If the liquid crystal touches your skin or clothes, wash it off immediately using soap and plenty of water
- 4) If pressure is applied to the display surface or its neighbourhood of the display module, the cell structure may be damaged and be careful not to apply pressure to these sections.
- 5) The polarizer covering the surface of the display module is soft and easily scratched. Please be careful when handling the display module.
- 6) When the surface of the polarizer of the display module has soil, clean the surface. It takes advantage of by using following adhesion tape.
 - a. Scotch Mending Tape No. 810 or an equivalent
 - b. Never try to breathe upon the soiled surface nor wipe the surface using cloth containing solvent such as ethyl alcohol, since the surface of the polarizer will become cloudy.
 - c. Also, pay attention that the following liquid and solvent may spoil the polarizer:
 - Water
 - Ketone
 - Aromatic Solvents
- 7) Hold the display module very carefully when placing it into the system housing. Do not apply excessive stress or pressure to display module. And, do not over bend the film with electrode pattern layouts. These stresses will

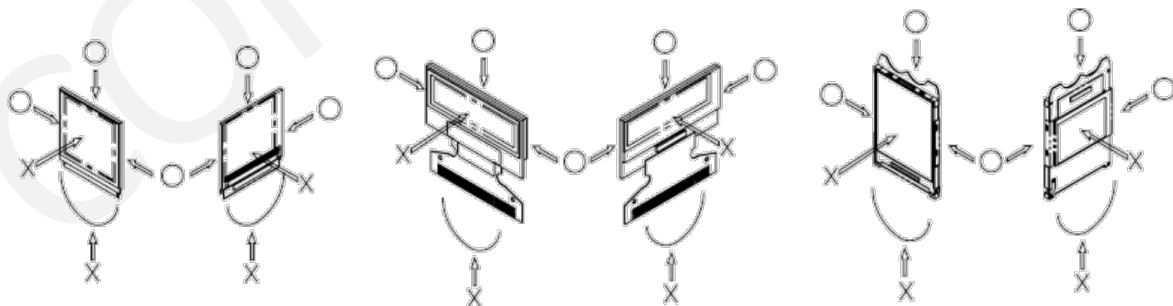

influence the display performance. Also, secure sufficient rigidity for the outer cases.

- 8) Do not apply stress to the LSI chips and the surrounding molded sections.
- 9) Do not disassemble nor modify the display module.
- 10) Do not apply input signals while the logic power is off.
- 11) Pay sufficient attention to the working environments when handing display modules to prevent occurrence of element breakage accidents by static electricity.

- a. Be sure to make human body grounding when handling display modules.
 - b. Be sure to ground tools to use or assembly such as soldering irons.
 - c. To suppress generation of static electricity, avoid carrying out assembly work under dry environments.
 - d. Protective film is being applied to the surface of the display panel of the display module. Be careful since static electricity may be generated when exfoliating the protective film.
- 12) Protection film is being applied to the surface of the display panel and removes the protection film before assembling it. If the display module has been stored for a long period of time, residue adhesive material of the protection film may remain on the surface of the display panel after removed of the film. In such case, remove the residue material by the method introduced in the above Section 5).
- 13) If electric current is applied when the display module is being dewed or when it is placed under high humidity environments, the electrodes may be corroded and be careful to avoid the above.

10.2 Storage Precautions

- 1) When storing display modules, put them in static electricity preventive bags avoiding exposure to direct sun light nor to lights of fluorescent lamps, etc. and, also, avoiding high temperature and high humidity environments or low temperature (less than 0°C) environments. (We recommend you to store these modules in the packaged state when they were shipped from Densitron) At that time, be careful not to let water drops adhere to the packages or bags nor let dewing occur with them.
- 2) If electric current is applied when water drops are adhering to the surface of the display module, when the display module is being dewed or when it is placed under high humidity environments, the electrodes may be corroded and be careful about the above.

10.3 Designing Precautions

- 1) The absolute maximum ratings are the ratings which cannot be exceeded for display module, and if these values are exceeded, panel damage may be happen.
- 2) To prevent occurrence of malfunctioning by noise, pay attention to satisfy the VIL and VIH specifications and, at the same time, to make the signal line cable as short as possible.
- 3) We recommend you to install excess current preventive unit (fuses, etc.) to the power circuit (VDD). (Recommend value: 0.5A)
- 4) Pay sufficient attention to avoid occurrence of mutual noise interference with the neighbouring devices.
- 5) As for EMI, take necessary measures on the equipment side basically.
- 6) When fastening the display module, fasten the external plastic housing section.
- 7) If power supply to the display module is forcibly shut down by such errors as taking out the main battery while the display panel is in operation, we cannot guarantee the quality of this display module.

10.4 Operation Precautions

- 1) It is indispensable to drive the display within the specified voltage limit since excessive voltage shortens its life.
- 2) Direct current causes an electrochemical reaction with remarkable deterioration of the display quality. Give careful consideration to prevent direct current during ON/OFF timing and during operation.
- 3) Response time is extremely delayed at temperatures lower than the operating temperature range while, at high temperatures, displays become dark. However, this phenomenon is reversible and does not mean a malfunction or a display that has been permanently damaged.
- 4) To protect display modules from performance drops by static electricity rapture, etc., do not touch the following sections whenever possible while handling the display modules.
 - a. Pins and electrodes
 - b. Pattern layouts such as the FPC
- 5) When the driver is being exposed (COG), semiconductor elements change their characteristics when light is radiated according to the principle of the solar battery. Consequently, if the driver is exposed to light, malfunctioning may occur.
 - a. Design the product and installation method so that the driver may be shielded from light in actual usage.
 - b. Design the product and installation method so that the driver may be shielded from light during the inspection processes.
- 6) Although the display module stores the operation state data by the commands and the indication data, when excessive external noise, etc. enters into the module, the internal status may be changed. It therefore is necessary to take appropriate measures to suppress noise generation or to protect from influences of noise on the system design.
- 7) We recommend you to construct its software to make periodical refreshment of the operation statuses (re-setting of the commands and re-transference of the display data) to cope with catastrophic noise.

10.5 Other Precautions

- 1) Request the qualified companies to handle industrial wastes when disposing of the display modules. Or, when burning them, be sure to observe the environmental and hygienic laws and regulations.